

SECRET

LOS ALAMOS SCIENTIFIC LABORATORY

OF THE UNIVERSITY OF CALIFORNIA
LOS ALAMOS, NEW MEXICO

CONTRACT W-7405-ENG. 36 WITH THE
U.S. ATOMIC ENERGY COMMISSION

LOS ALAMOS NATIONAL LABORATORY



3 9338 00407 4026

SECRET
RESTRICTED DATA

THIS CONTRACT CONTAINS RESTRICTED DATA AS DEFINED IN THE ATOMIC ENERGY ACT OF 1954. ITS TRANSMISSION OR THE DISCLOSURE OF ITS CONTENTS IN ANY MANNER TO AN UNAUTHORIZED PERSON IS PROHIBITED.

[REDACTED]

LOS ALAMOS SCIENTIFIC LABORATORY
of the
UNIVERSITY OF CALIFORNIA

Report written:
November 4, 1954

PUBLICLY RELEASABLE
Per MARK M. ENDS. FSS-16 Date: 10/27/95
By Angela DeB. CIC-14 Date: 11/8/95

LA-1883 This document consists of 26 pages

0.9

[REDACTED]

ELECTRICAL RESISTIVITY OF PLUTONIUM METAL
AND OF GALLIUM-PLUTONIUM ALLOYS OVER
THE TEMPERATURE RANGE OF 26°K to ~ 773°K

UNCLASSIFIED

by
R. B. Gibney
T. A. Sandenaw

Classification changed to UNCLASSIFIED
by authority of the U. S. Atomic Energy Commission,
Topic 1.0591 Rev. C.G.-XV-1 Jan. 30, 1960
Per Letter to Currier from Keenan DEC 9 1960
attd. 5-27-64
By REPORT LIBRARY See 12-4-64

LOS ALAMOS NATL LAB LIBS
3 9338 00407 4026

[REDACTED]

[REDACTED]

[REDACTED]

UNCLASSIFIED

[REDACTED]

~~SECRET~~

Report distributed: JUL 20 1955

AEC Classified Technical Library
University of California Radiation Laboratory, Livermore
Los Alamos Report Library

LA-1883

1-7

8

9-30

~~SECRET~~

UNCLASSIFIED



ABSTRACT

Electrical resistivity measurements have been made on high-purity plutonium metal and 3.5 atomic percent and 5 atomic percent gallium-plutonium alloys over the temperature range of 26°K to approximately 773°K.

The resistivity of plutonium metal reaches a maximum at 100°K. From 100°K to 650°K the material has a negative temperature coefficient of resistance (α , β and γ phases). The slope becomes positive in the δ and δ' phases. The ϵ phase had a zero temperature coefficient within experimental error. From 400°K to 773°K the resistance-temperature curve of the plutonium metal is quite flat.

The electrical resistance of the 3.5 atomic percent gallium alloy peaked at 160°K. The resistivity values of the gallium-plutonium alloys vary only a few percent in a temperature range of 500°K.





1. Introduction

Electrical resistivity measurements have been made on two specimens of high-purity plutonium metal and on 3.5 atomic percent and 5 atomic percent gallium-stabilized, δ -phase plutonium alloys over the temperature range of 26°K to approximately 773°K .

Because of the importance of heat leaks at liquid hydrogen temperatures, it was convenient to devise one piece of apparatus to cover the range of 20°K to room temperature and another to cover the range of room temperature to slightly above 773°K .

Besides determining temperature coefficients of resistance in the various phases of the high-purity metal, it was possible to determine phase-change temperatures quite accurately.

One of the high-temperature determinations of electrical resistivity of the high-purity metal was done under conditions in which the furnace and surroundings were caused to follow the self-heating of the plutonium rod. This heating was not strictly adiabatic because of the mass of material in close contact with the specimen.

2. Experimental

2.1 Low-temperature Apparatus and Procedure

In the apparatus for each temperature range, the current, potential and thermocouple leads were spring loaded because of the difficulty of making soldered connections to the plutonium.

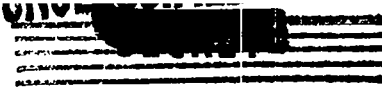
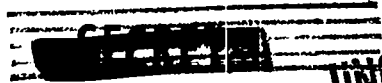

Figure 1 is a sketch of the assembly of the low-temperature electrical resistivity apparatus, which was designed to take a rod approximately 3-1/2 inches in length by 1/4 inch in diameter. The details of spring loading are shown at the side in the sketch.

Thermocouple wires were soldered into small holes drilled through the tip of the platinum pins used as potential contacts. The thermocouples were made from Leeds and Northrup No. 30 B and S Copper-Constantan Duplex Wire, enamel and glass insulation calibrated for low-temperature use. Millivolt readings were taken with a Leeds and Northrup Portable Precision Potentiometer, and resistivity measurements with a Leeds and Northrup Precision Kelvin Bridge. Gold-plated copper blocks were used as current contacts at the end of the test specimens.

A copper rod (also a current lead) from which the apparatus was suspended passed through a Wilson seal. All other electrical and thermocouple leads were taken from the vacuum space through Kovar-glass seals.

The test specimens were carefully polished to remove oxide and a micrometer was used to determine the average cross section in the length of rod between the potential contacts. After a specimen was placed in the spring-loaded assembly, the distance between potential contact points was carefully measured by means of a traveling microscope, and the copper can (wound with heater wire) was lifted up and fastened in place with small screws. Next the outer brass can was lifted up around the assembly and soft-soldered to vacuum tightness.

**UNCLASSIFIED**

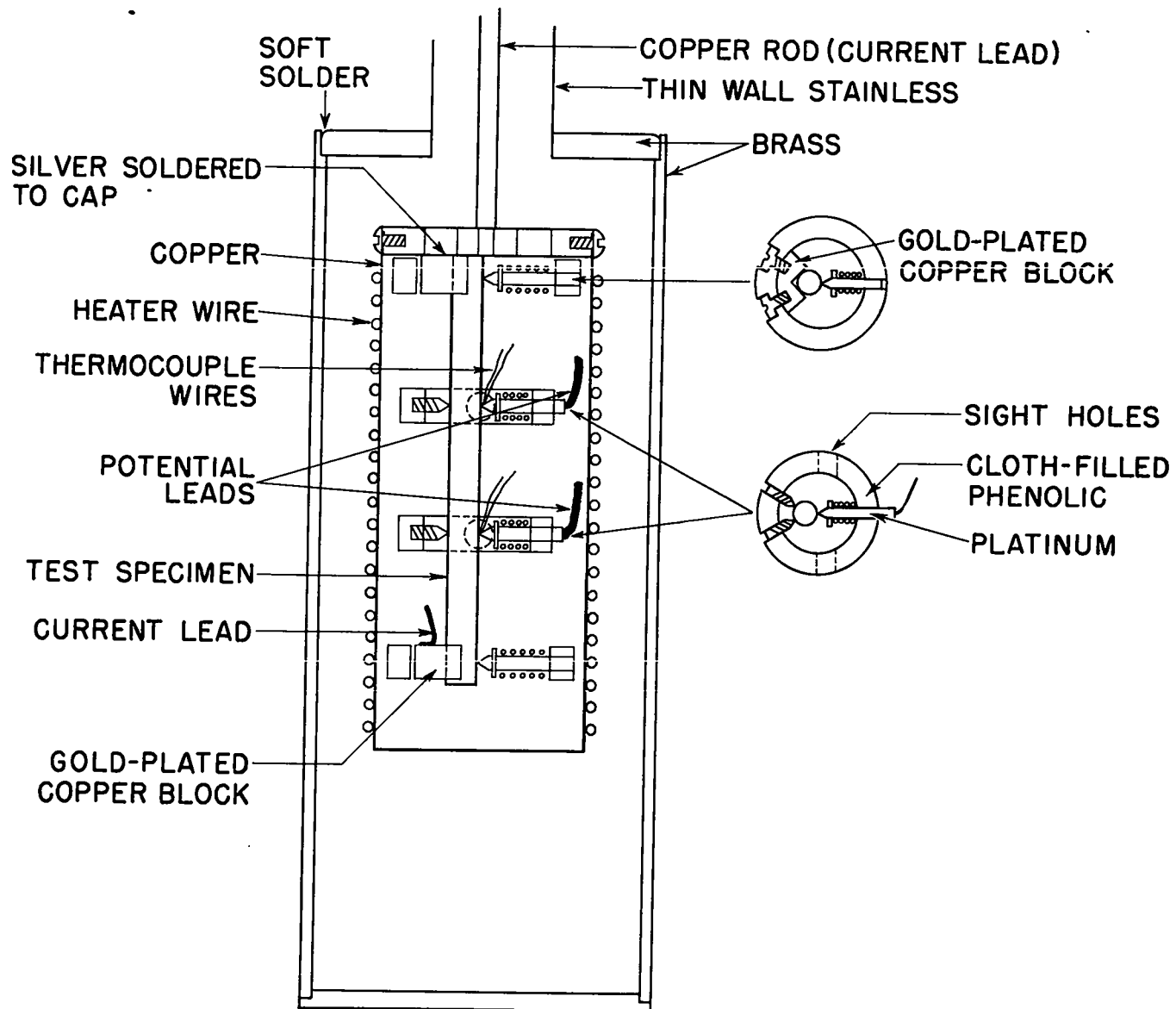

6

Fig. 1. Low-temperature electrical resistivity apparatus.



The dewar and cryostat were finally put in place around the brass outer can.

After leak-testing and pumping for a day (or longer), approximately 1 to 2 mm of helium were admitted to the vacuum space as heat-exchange gas. Liquid nitrogen was transferred to the dewar and when the assembly temperature had reached a constant value, the liquid nitrogen was removed. The temperature of the assembly increased very slowly, taking from 8 to 12 hours to reach room temperature. To warm up the specimen from liquid nitrogen temperature to 273°K in 9 hours, it was necessary to pass a slow flow of helium through the dewar system. Initially the temperature rise was around $1/3^{\circ}\text{K}$ to $1/2^{\circ}\text{K}$ per minute, but approaching room temperature, this dropped to $1/6^{\circ}\text{K}$ to $1/4^{\circ}\text{K}$ per minute. The heater on the inner copper can was used only to get readings above room temperature. Resistivity and temperature readings were taken at frequent intervals during warming to obtain the temperature-resistivity curve.

The first run from the temperature of liquid nitrogen to room temperature was made to prove that spring-loaded contacts to the test specimen were good and that the Kelvin bridge was working correctly. The assembly was again cooled with liquid nitrogen, the nitrogen was blown out of the dewar with helium gas, and liquid hydrogen was transferred into the dewar surrounding the test specimen. After the resistivity readings were obtained at approximately 26°K (lowest temperature reached because of heat leaks and the heat generated by

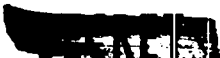



the plutonium), the liquid hydrogen was allowed to boil off and readings of resistivity and temperature were taken until the specimen was again at room temperature.

The comparison of values of resistivity vs temperature from liquid nitrogen and liquid hydrogen runs will be discussed in Sec. 3.

2.2 High-temperature Apparatus and Procedure

The high-temperature electrical resistivity apparatus was designed to take the same cylindrical rod specimens (3.5 inch length by 0.25 inch diameter) investigated in the low-temperature apparatus.

The two gallium alloys and one plutonium specimen were measured in an assembly which was a variation of the apparatus described in the following paragraphs.

The specimen was placed on a grooved lavite block, which was in turn supported at the center of a copper cylinder wound with heater wire. Placed at points below the current and potential contacts were thin, narrow strips of platinum to which were silver soldered the chromel-alumel thermocouples for measuring temperature. The thermocouples actually were in contact with the rod. The current and potential contacts were spring-loaded from the top of the copper cylinder and insulated from the cylinder by means of lavite spacers. The potential pins were constructed with a screwdriver tip at the point of contact to the specimen. Springs used for loading were made of Inconel "X" wire for heat resistance.

The copper cylinder was spaced in its surrounding stainless steel



SECRET

vacuum jacket by a lavite block and supported on one end by bolt studs and thin-wall stainless steel tubing connected to a water-cooled can, which was in turn connected to the cover of the stainless steel vacuum jacket. Three radiation shields were spaced between the water-cooled cover and the copper cylinder. The current, potential drop and thermocouple wires from the test specimen were wrapped around the recessed end of the copper can before taking them to the water-cooled can for several more turns prior to soldering them into Kovar-glass thermocouple feed-through headers. The cooling of lead wires was to prevent melting of the soft solder used to seal wires in the Kovar-glass headers. The wires were wrapped around the copper cylinder so that they would be warmed to furnace temperature before making contact to the test specimen.

After insertion of the test specimen into the copper cylinder, thin copper end plates (additional radiation shields) were fastened into place on the ends of the copper cylinder.

A differential thermocouple was connected between a platinum strip under the test specimen and the inner copper cylinder. This differential thermocouple was fed to a Brown Electropulse Relay and Proportional Controller which controlled the d.c. current fed to the heater wound on the copper cylinder, the object being to permit the plutonium specimen to warm up as nearly adiabatically as possible with the set-up. The temperature of the surrounding copper cylinder was biased to lead the specimen by several microvolts except at phase changes. The furnace surrounding the stainless steel vacuum jacket

SECRET

was controlled manually to lead the specimen and its surrounding copper cylinder by several degrees.

Although the above paragraph outlines the objective of the heating cycle of the test specimens, this procedure was not followed with the first specimen because of apparatus failures. The actual heating time was approximately one-third of that taken in heating the second specimen under something resembling adiabatic conditions.

The first plutonium specimen (No. 1928) placed in the high-temperature apparatus was heated at about $3/4^{\circ}\text{C}$ per minute up to the α - β transition and then at an average rate of 1°C per minute up to 773°K (500°C). The second high-purity specimen rose in temperature at a rate which varied around $1/3^{\circ}\text{C}$ per minute except at phase transitions.

The 3.5 atomic percent gallium-stabilized, δ -phase specimen was heated to 235°C (508°K) on one day, held slightly under this temperature overnight and heated to 486°C (759°K) on the second day at a rate of $2/3^{\circ}\text{C}$ per minute. The 5 atomic percent specimen was heated in the high-temperature apparatus at a rate slightly less than 1°C per minute up to 770°K , with readings taken at frequent intervals.

Thermocouples were made of chromel-alumel wires for the high-temperature run. The actual thermocouples used (silver soldered to the platinum strips) were calibrated at the steam point and at the freezing point of U. S. Bureau of Standards samples of tin, lead, zinc, and aluminum.

The Leeds and Northrup Portable Precision Potentiometer used in

measuring temperatures was checked against a Type K-2 Potentiometer previously calibrated by the Los Alamos Standards Laboratory. Maximum differences were 4 microvolts in the range 90°C to 500°C.

In both the low- and high-temperature assemblies, there were sight holes through the retaining ring or surrounding cylinder to permit measurements of the distance between potential drop contact points with a traveling microscope. In the low-temperature apparatus the contact points were arbitrarily set about 3 cm apart. The points were closely fixed at 4 cm apart in the high-temperature apparatus.

2.3 Specimen Preparation and Purity

The plutonium specimens were prepared from high-purity material and cast oversize in CaO crucibles. The maximum remelting temperature of specimen 1928 was 850°C. Because of a flaw in the casting, the first rod specimen was machined to 0.217 inch in diameter. It was not bright polished and was submitted in anhydrous ethyl alcohol. The second specimen (No. 2202) was machined to a nominal and quite uniform 0.250 inch diameter and polished brightly before placing in anhydrous ethyl alcohol for refrigerated storage until measurements could be made.

Table I shows the chemical composition of the metal in specimen 1928. The material submitted for analysis was from the melting and casting stock and from the top and bottom ends of the rod after the high-temperature run.

It was requested that turnings from the machining of specimen 2202 be carefully taken from each end and submitted for chemical

TABLE I

CHEMICAL ELEMENTS PRESENT IN PLUTONIUM SPECIMEN 1928

Element	Melting Stock, ppm	Samples Taken after High-temperature Run	
		Top-end Turnings, ppm	Bottom-end Turnings, ppm
C	20	50, 50, 40, 45	55, 55
S	65	----	----
Li	< 0.2	< 0.2	< 0.2
Be	< 0.2	< 0.2	< 0.2
Na	< 5	< 10	< 10
Mg -	< 3	< 5	< 5
Ca	< 3	< 5	< 5
Al	< 5	< 5	< 5
La	< 10	< 10	< 10
Si	10	3	3
Pb	3	< 1	< 1
Cu	15	5	5
Ni	3	3	1
Cr	< 5	5	< 5
B	0.4	----	----
Mn	15	----	----
Sn	3	----	----
Bi	< 1	----	----
Fe	10-40	215	130
V	< 20	----	----
Co	< 5	----	----
Ba	< 10	----	----
Mo	< 20	----	----
Sb	< 10	----	----
As	< 20	----	----
Zn	< 20	----	----
O	----	60, 190	80, 190



analysis. Results of this analysis and for material sampled from the ends of this cylindrical rod after the high-temperature run are shown in Table II.

The calcium content in parts per million is indicated to be rather high in original turnings from the top end of specimen 2202, while calcium is negligible in turnings from this same rod after the measurements up to 500°C. Since the rod was cast in a CaO crucible, part of the crucible may have gotten into the material for analysis, or there may have been some CaO-rich slag trapped in the top-end metal.

The density of specimen 1928 was 19.64 and of 2202 was 19.63.

The δ -phase, stabilized plutonium specimens were prepared as cylindrical rods for resistivity measurements. Table III gives the specimen numbers, their sizes and their heat treatments. Also is shown the initial resistivity of each specimen, as well as the final resistivity after slow cooling from the top temperature reached with each rod.

Two specimens were made from the same 3.5 atomic percent gallium melt and these were numbered 1907-a and 1907-b. Measurements at high temperatures were made first with specimen 1907-a, and specimen 1907-b was held back and used in the low-temperature measurements.

3. Results

In Fig. 2, the resistance of each of the high-purity test specimens is plotted as 100 times the resistance at any specified



SECRET

TABLE II

CHEMICAL ELEMENTS PRESENT IN SPECIMEN 2202

Element	Melting Stock, ppm	Original Machining		After High-temp. Run	
		Top Turnings, ppm	Bottom Turnings, ppm	Top Turnings, ppm	Bottom Turnings, ppm
C	20	320, 360	80, 90	145, 120	90, 60
S	< 10	----	----	----	----
Li	----	< 0.2	< 0.2	< 0.2	< 0.2
Be	----	< 0.2	< 0.2	< 0.2	< 0.2
Na	< 5	< 10	< 10	< 10	< 10
Mg	< 3	< 5	< 5	< 5	< 5
Ca	40	150 to 800	5	< 5	< 5
Al	< 5	< 5	< 5	< 5	< 5
La	10	< 10	< 10	< 10	< 10
Si	----	3	< 1	3	3
Pb	----	3	3	1	1
Cu	----	1	3	3	5
Ni	----	< 1	< 1	1	1
Cr	----	----	----	----	----
B	< 0.5	----	----	----	----
Mn	30	----	----	----	----
Fe	50	70	35	225	265
V	< 20	----	----	----	----
Co	----	----	----	----	----
Ba	----	----	----	----	----
Mo	< 20	----	----	----	----
Sb	< 10	----	----	----	----
As	< 20	----	----	----	----
Zn	< 20	----	----	----	----
O	----	----	----	440, 710	340, 380

TABLE III

DESCRIPTION OF STABILIZED PLUTONIUM SPECIMENS

Specimen number	3.5 Atomic Percent Gallium		5 Atomic Percent Gallium
	1907-a	1907-b	1886-1
Specimen size, inches	0.025 diam. x 3.5	0.246 diam. x 3.5	0.217 diam. x 3.5
Treatment	Not heat treated	Not heat treated	Homogenized
Initial resistivity, ρ ($\mu\text{ohm cm}$)	114.5 \pm 1.0	113.9 \pm 1.0	114.9 \pm 1.0
Final resistivity, ρ ($\mu\text{ohm cm}$), after slow cooling from 490°C or 500°C	113.5 \pm 1.0	----	113.0 \pm 1.0
Final resistivity, ρ ($\mu\text{ohm cm}$), after cooling with liquid N ₂ three times and liquid H ₂ one time	----	117.1	----

temperature over the resistance at 0°C vs the absolute temperature. The peak in resistance is at approximately 100°K ; and from 100°K to 600°K , the temperature coefficient of resistance is always negative. From 400°K to 787°K , the percentage change in resistance is not very great; i.e., approximately 13%.

As noted in Sec. 2.1, each specimen was checked at the temperature of liquid nitrogen and allowed to warm up to room temperature before cooling again with liquid nitrogen and hydrogen. Then resistivity readings were taken from the low temperatures until room temperature was reached. The reproducibility of resistivity readings was as follows: At room temperature the initial value of resistivity of specimen 1928 differed from the final value by 0.3%, after being down to approximately 26°K . This same difference in the case of specimen 2202 was only 0.05%. In the case of the first specimen tested, the resistivity at the temperature of maximum resistance, i.e., 100°K , differed on the liquid nitrogen and liquid hydrogen runs by 0.1%. The difference in resistance of the second specimen at 100°K in the liquid nitrogen and liquid hydrogen runs was only 0.05%.

In Fig. 3, the calculated volume resistivity of specimen 2202 is plotted vs temperature in degrees Kelvin. The dilatometer data from a high-purity specimen was supplied by LASL Group CMR-5 and used in the computation of values from room temperature to 524°C . The low-temperature dilatometer data (room temperature to approximately -200°C) used was for material of normal purity. As noted before, the high-temperature

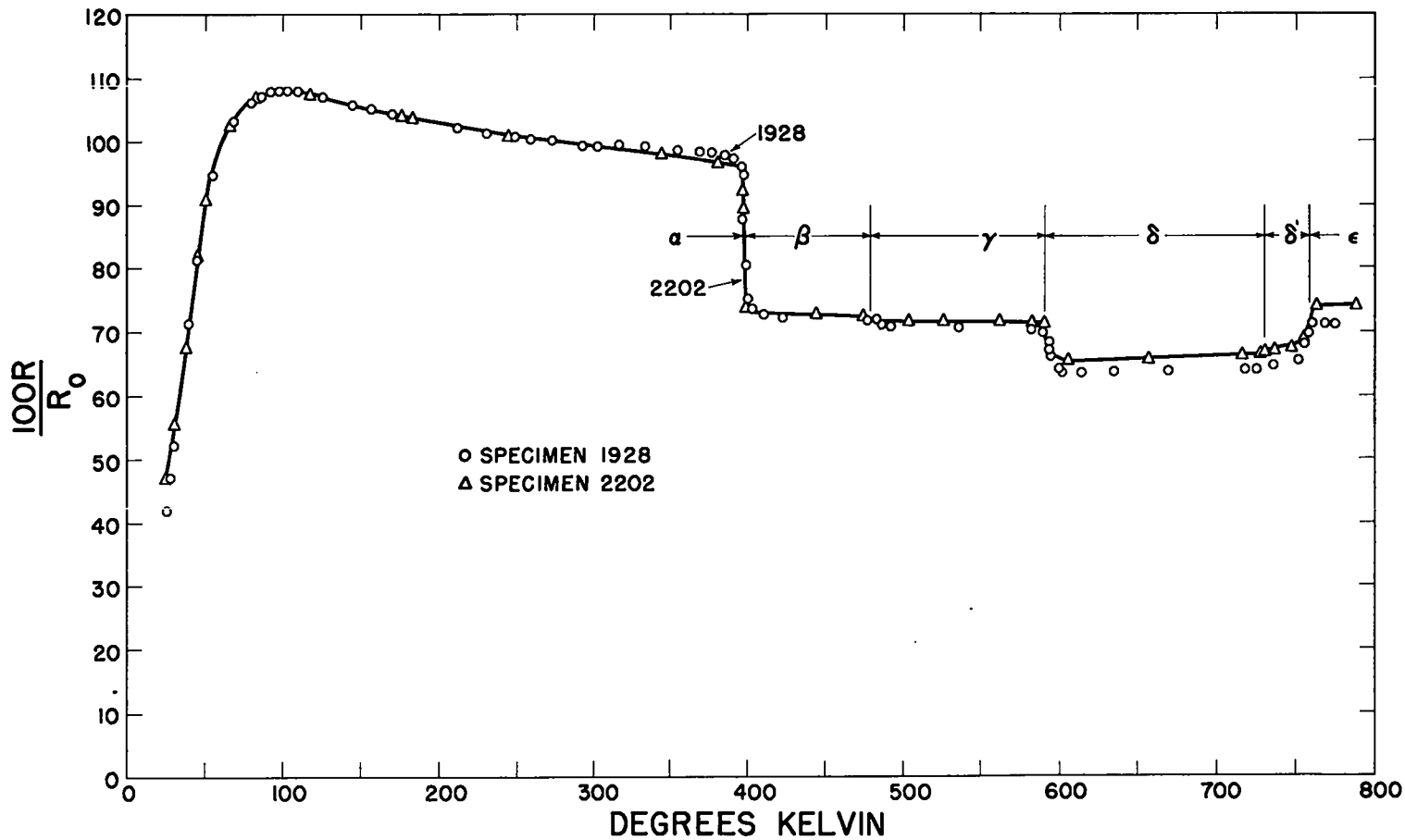

Fig. 2. $100R/R_0$ vs absolute temperature for plutonium specimens.

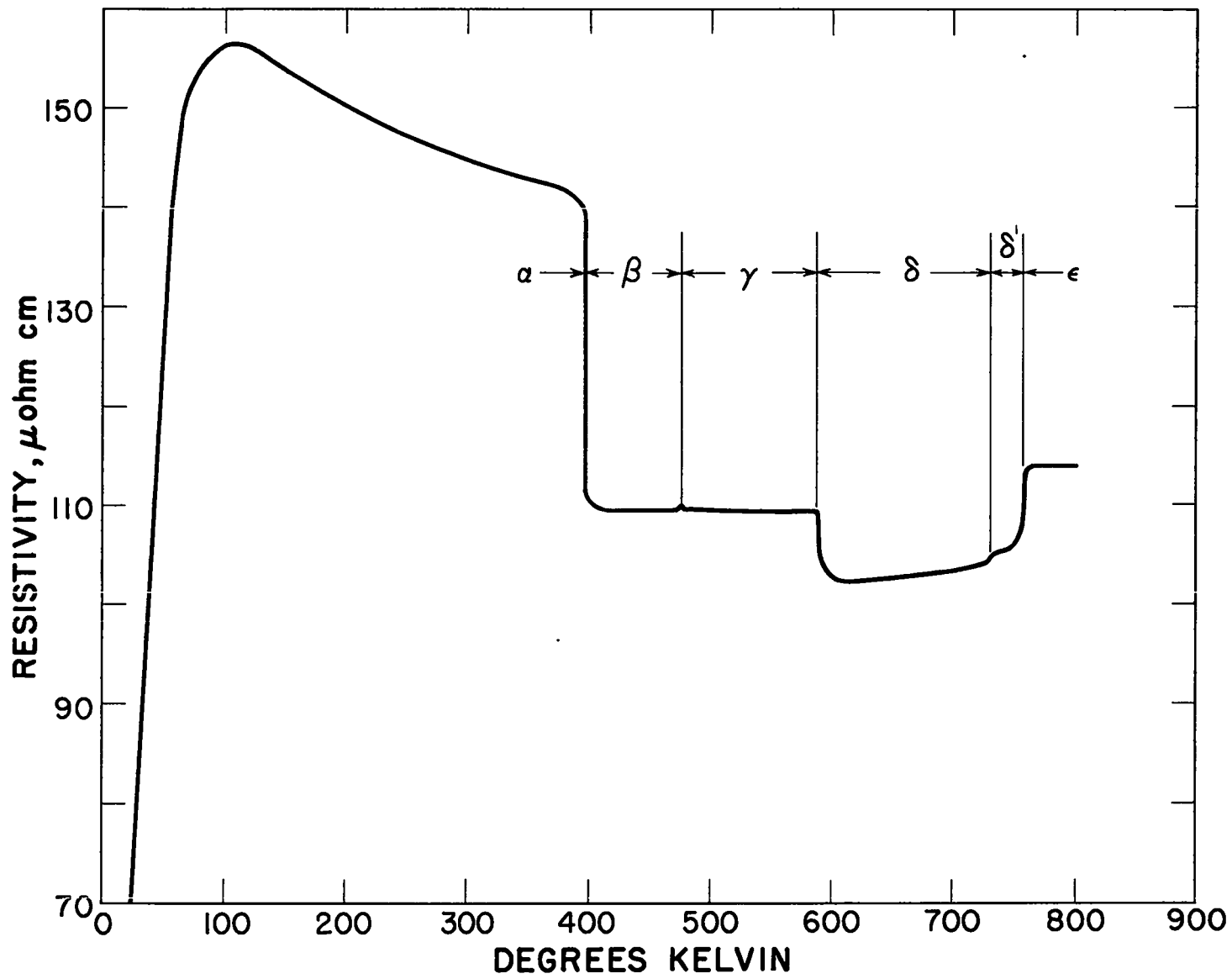

Fig. 3. Electrical resistivity of plutonium vs absolute temperature (specimen 2202).

resistivity values, plotted in Fig. 3, were obtained under conditions of self-heating of the rod. It is evident from this figure that the change in resistivity at the β - γ and δ - δ' transitions is not very great.

Comparable values of resistivity of the two pure specimens taken from the smoothed-out temperature-resistivity curves for each specimen are given in Table IV.

TABLE IV

COMPARISON OF RESISTIVITY VALUES OF HIGH-PURITY PLUTONIUM SPECIMENS

Temperature, K	Resistivity, $\mu\text{ohm cm}$ (from Smoothed-out Curves)	
	Specimen 1928	Specimen 2202
26	61.1	----
26.5	----	68.5
50	127.0	130.0
100	157.0	156.5
150	153.5	153.5
273.2	146.3	146.6
380	141.0	141.8
420	107.5	109.5
475	107.0	110.0
505	106.2	109.5
590	105.0	109.3
625	97.7	103.0
725	98.5	104.0
735	99.4	104.8
774	107.1	114.0
787	----	114.1

Table V compares the temperature coefficient of resistance of the two high-purity specimens, where temperature coefficient of resistance is defined as the ratio of change of resistance in a specimen due to a change of temperature of 1°C to its resistance at 0°C .

TABLE V

TEMPERATURE COEFFICIENT OF RESISTANCE OF HIGH-PURITY PLUTONIUM SPECIMENS

Temperature Range, °K	Phase	$\frac{1}{\rho_0} \frac{d\rho}{dT} (\times 10^5)$	
		Specimen 1928	Specimen 2202
27-50	α	+1948.0 \pm 3.0	+1733.0 \pm 3.0
126-293	α	-42.7 \pm 0.4	-40.9 \pm 0.4
302-381	α	-15.0 \pm 1.0	-26.5 \pm 1.0
420-470	β	-7.4 \pm 1.2	-5.1 \pm 1.0
503-590	γ	-6.2 \pm 1.2	-3.9 \pm 1.0
625-725	δ	+5.1 \pm 1.0	+9.4 \pm 1.0
736-747	δ'	+39.9 \pm 4.0	+48.7 \pm 5.0
761-775	ϵ	0.0 \pm 5.0	0.0 \pm 5.0

Table VI gives the phase change temperatures as determined from the resistivity measurements. It should be remembered that the heating cycle for specimen 1928, from room temperature to 500°C, was forced, while for specimen 2202 the heating cycle followed self-heating of the specimen itself.

TABLE VI

PHASE CHANGE TEMPERATURES AS INDICATED BY RESISTIVITY MEASUREMENTS

Phase Change	Specimen 1928		Specimen 2202	
	°C	°K	°C	°K
α - β	123.8 \pm 0.2	397.0 \pm 0.2	123.2 \pm 0.1	396.4 \pm 0.1
β - γ	205.4 to 226	478.6 to 485.8	201.5 \pm 0.2	474.7 \pm 0.2
γ - δ	319.5 \pm 0.5	592.7 \pm 0.5	316.9 \pm 0.5	590.1 \pm 0.5
δ - δ'	454.3 to 458.5	727.5 to 731.7	456.0 \pm 1.0	729.2 \pm 1.0
δ' - ϵ	480.5 to 486.7	753.7 to 759.9	480.0 to 487.4	753.2 to 760.6

The curve of Fig. 4 compares the resistivity of the gallium alloys at a given temperature to the resistivity at 25°C. This was necessary

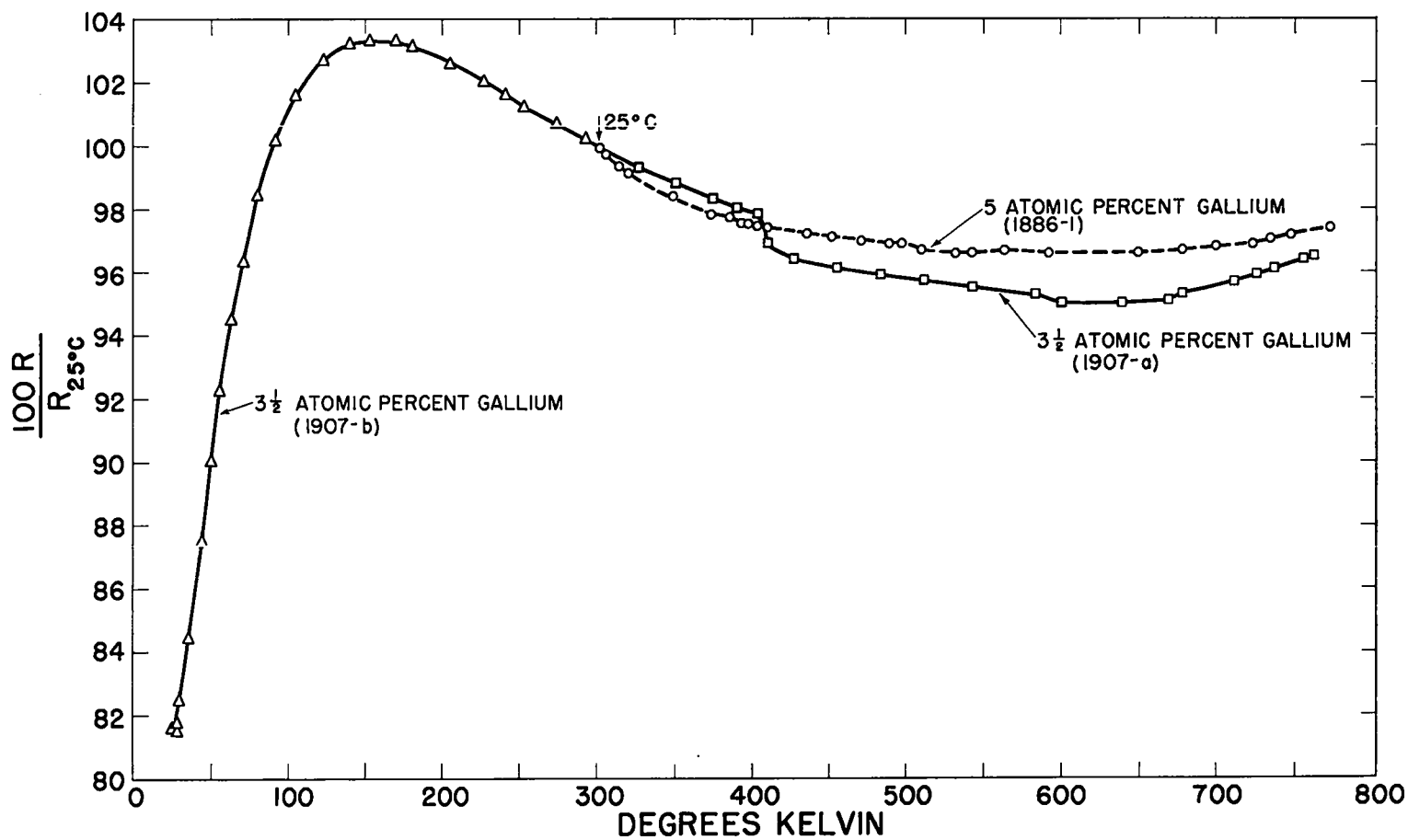

Fig. 4. $100R/R_{25^{\circ}C}$ vs absolute temperature for gallium-plutonium alloys.

because neither of the gallium alloy specimens placed in the high-temperature apparatus had resistivity measured at 0°C. Figure 4 shows that the resistivity of the 3.5 atomic percent specimen varies only a few percent in the temperature range 150°K to 760°K. There was a slight drop in resistance at the α - β phase transition temperature, showing the presence of some α -material. In the low-temperature measurements, the resistance peaks at 160°K, which is 60°K higher in temperature than the peak for plutonium metal. The resistance at 26°K is still 81.5% of the room temperature value.

The 5 atomic percent gallium-stabilized δ -phase plutonium (heat treated) had a fairly flat resistance curve over the entire range of temperature measurements. Measurements of resistance of the 3.5 atomic percent specimen (1907-a) were taken at intervals while it slowly cooled back to room temperature. This cooling curve was even flatter than the heating curve and was consistently higher than on the heating cycle until a temperature of 147.7°C (420.9°K) was reached, when there was a crossover. The cooling curve of resistance was then parallel to the original heating curve from about 140°C on down to room temperature, where the final value was 99.1% of the original room temperature value. The slow cooling from the top temperature of 761.7°K to room temperature had a homogenizing and stabilizing effect, because on heating a second time there was no sudden drop in resistance at the α - β phase transition temperature. This second curve paralleled very closely the one found for heat-treated 5 atomic percent gallium alloy, as shown in

 UNCLASSIFIED

Fig. 4. As noted above, the curve for this latter alloy is quite flat over the entire temperature range from 293°K to 773°K.

Readings of resistance were taken while cooling the 5 atomic percent specimen (1886-1) down to 269°C. The temperature resistance curve on cooling was also above the heating cycle curve.

4. Discussion

In examining the curves of resistivity vs temperature in the case of high-purity plutonium, one notices that only in the low-temperature region of 26°K to 100°K does the material have a resistivity typical of a metal.

Low-temperature measurements of electrical resistivity were made on a plutonium specimen of low purity at a much earlier date than that for measurements reported here. The position of the hump (i.e., 100°K) did not appear to be shifted in the less pure material, but resistance values were slightly lower. This could be explained because the lower-purity material was of lower density and slight amounts of β -phase (with lower resistivity) could have been present.

The hump in the resistance curve of plutonium at 100°K is very similar to the humps reported in lead or tin alloys of bismuth by N. Thompson.* As small amounts of tin or lead are added to bismuth, humps appear in the resistance. With a sufficient amount of tin or

* N. Thompson, "The Electrical Resistance of Bismuth Alloys." Proc. Roy. Soc. London, A155, 111 (1936).

 UNCLASSIFIED

~~CONFIDENTIAL~~

lead present in bismuth, the curve possesses a maximum in resistance. The position of this maximum moves to higher temperatures as the quantity of tin or lead is increased.

It has been noted in Sec. 3 that the resistivity of the 3.5 atomic percent stabilized alloy (1907-b) peaked at 160°K , which was 60°K higher than for the pure plutonium. It appears that the effect of gallium is about the same on plutonium as additional tin or lead in the bismuth alloys.

From 100°K to 605°K , the pure material has a negative temperature coefficient of resistance. The temperature coefficient of resistance is thus negative in the α , β and γ phases and shows slight positive value in the δ and δ' phases. The ϵ phase had a slightly positive temperature coefficient of resistance in one specimen and a slightly negative coefficient in the other specimen. These values were essentially zero within experimental error, due to the shortness of the temperature range and the softness of the metal.

There was found to be an uncertainty of $\pm 0.4\%$ in measurement of distance between the potential drop probes of the precision Kelvin Bridge Circuit. On repeated runs (on different days) down to the temperature of liquid nitrogen with specimen 1907-b, it was found that the room temperature value of volume resistivity could vary as much as 1.4% . The room temperature value of volume resistivity should therefore be good to $\pm 1\%$.

In the temperature range covered by each of the runs mentioned in

~~CONFIDENTIAL~~
UNCLASSIFIED

~~SECRET~~ UNCLASSIFIED

the previous paragraph, values of $100R/R_{25^{\circ}\text{C}}$ were calculated, using the resistance found at 25°C on the particular day of the run for the calculations. In comparing three low-temperature runs, it was found that values of $100R/R_{25^{\circ}\text{C}}$ at a single temperature differed at most by three parts in 1000 or by 0.3%. It is believed that the low-temperature values of $100R/R_{25^{\circ}\text{C}}$ (specimen 1907-b) are good to $\pm 0.5\%$ and that the high-temperature values for specimen 1886-1 are good to $\pm 1\%$, if not better.

Admittedly, if specimen 1907-a had been heat treated before making the first resistance measurements, the curve would have been flatter and more like the curve for specimen 1886-1.

It should be noted that all resistance measurements given in this report were parallel to the principal axis of the original casting. No measurements were made of resistance perpendicular to the principal axis and anisotropy may have considerable effect.

An examination of Fig. 2 and/or Table IV shows that the low-temperature resistivity of each high-purity specimen was very comparable (at a given temperature) from approximately 26°K to room temperature. In the higher temperature phases, the values of resistivity were spread apart and the temperature coefficients were different (Table V). The inconsistency in high-temperature values even carries over to the phase-change temperatures, which differ by as much as 3.9°C in the two samples. The differences in indicated temperature of a phase change could be influenced by rate of heating, which was different for the two

~~SECRET~~ UNCLASSIFIED

pure specimens; and also by location of thermocouples, as the reported temperatures are an average of the two readings taken at time of resistance measurements.

Magnetic susceptibility measurements made by A. A. Comstock of LASL Group (MR-13) show considerable scatter in values in the phases occurring at temperatures above the α -phase. Above the α - β transition temperature, reproducibility does not appear to be very good in either resistivity or magnetic susceptibility measurements.